

Flush Mount PIR Motion Sensor 

HIR28	HIR28/R	HIR28/H	HIR28/RH
Low-bay	Reinforced Low-bay	High-bay	Reinforced High-bay



Applications

Office, classroom and commercial interior spaces where on/off control is required.

- Office / Commercial Lighting
- Classrooms
- Stairwells / Corridors

HIR28 with on/off relay control





Designed with a low profile for aesthetically demanding architectural projects providing a high quality sensor for simple on/off occupancy control or providing semi-automatic (absence detection) control.

An intelligent photocell is also included to prevent switching of the lights when natural daylight is available

Set-up of the sensor is carried out using a remote control handset with program memory allowing one-key commissioning where common settings are used for multiple devices.



Features

-  Store settings in the remote for easy commissioning when programming multiple sensors.
-  Intelligent photocell - lights and sensors only operate when needed, natural light has priority.
-  Zero crossing detection to reduce in-rush current and maximise relay life.
-  5 Year, 50,000hr Warranty

Technical Data

Input Characteristics

Model No.	HIR28
Mains voltage	220~240VAC 50/60Hz
Stand-by power	<1W
Load ratings:	
Capacitive	400W
Resistive	800W
Warming-up	20s

Safety and EMC

EMC standard (EMC)	EN55015, EN61000
Safety standard (LVD)	EN60669-1, EN60669-2-1
Certification	Semko, CB, CE, EMC, LVD, RCM

Sensor Data

Model No.	HIR28
Sensor Model	PIR detection
Detection range (Max.)* HIR28	Installation Height : 6m Detection Range(Ø) : 9m
Detection range (Max.)* HIR28/R	Installation Height : 6m Detection Range(Ø) : 10m
Detection range (Max.)* HIR28/H	Installation height: 1.5m (forklift) 1.2m (person) Detection range (Ø) : 24m
Detection range (Max.)* HIR28/RH	Installation height: 1.5m (forklift) 1.2m (person) Detection range (Ø) : 40m
Detection angle	360°

* For more details of detection range, please refer to "detection pattern" section.

Environment

Operation temperature	Ta: -20°C ~ +50°C
IP rating	IP20

Mechanical Structure

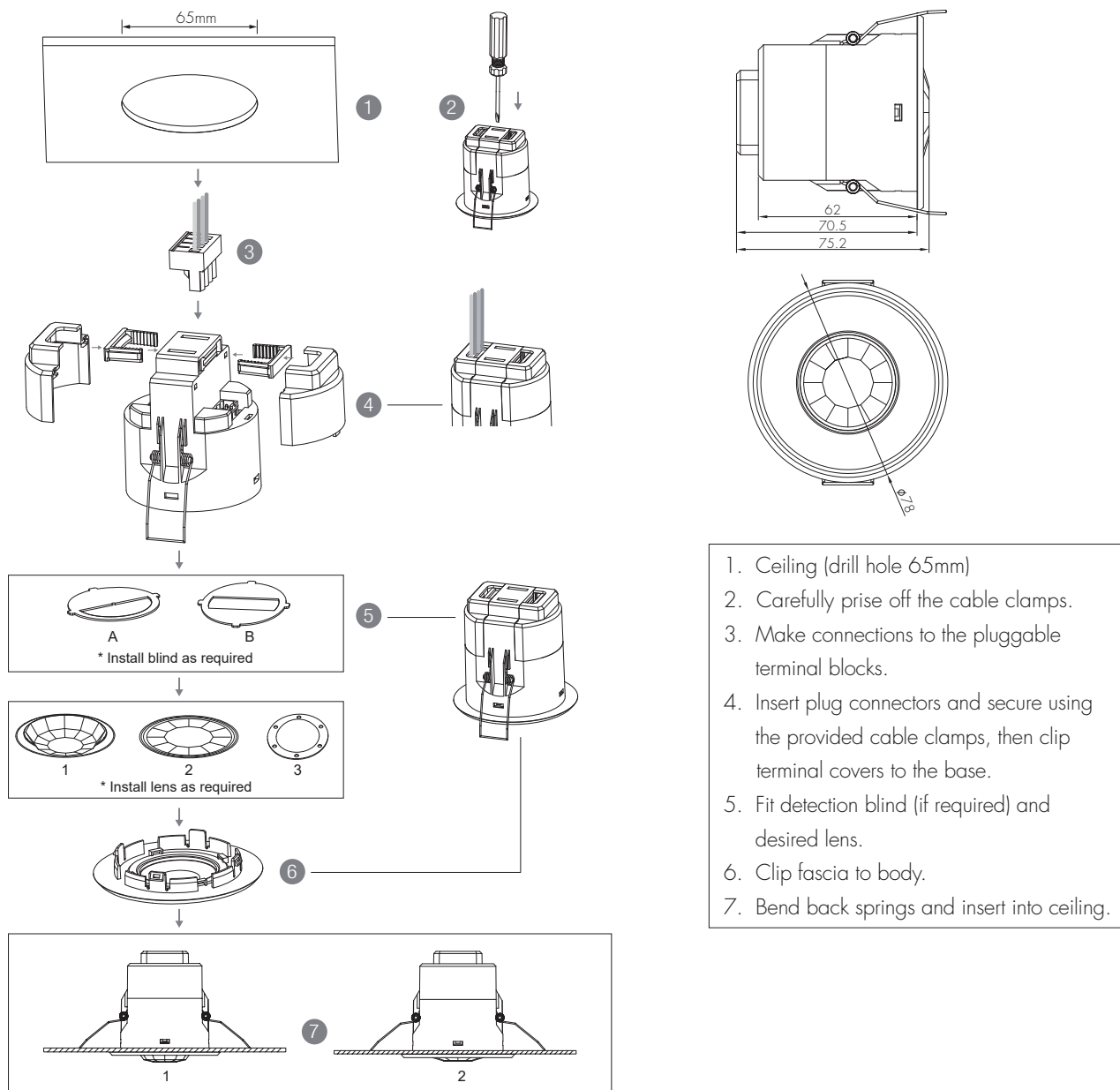

1. Ceiling (drill hole 65mm)
2. Carefully prise off the cable clamps.
3. Make connections to the pluggable terminal blocks.
4. Insert plug connectors and secure using the provided cable clamps, then clip terminal covers to the base.
5. Fit detection blind (if required) and desired lens.
6. Clip fascia to body.
7. Bend back springs and insert into ceiling.

Note: We recommend the mounting distance between sensor to sensor should be more than 2m to prevent sensors from false-triggering.

Wire Preparation

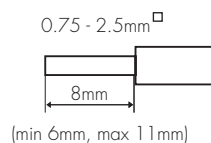

Pluggable screw terminal. It is recommended to make connections to the terminal before fitting to the sensor.

Wiring Diagram

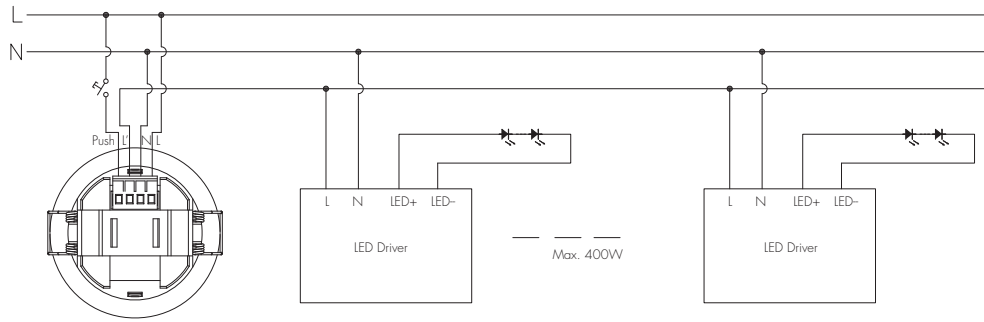

Detection Pattern & Optional Accessories

1. HIR28 (Low-bay)

HIR28: Low-bay flat lens detection pattern for single person @ Ta = 20°C

(Recommended ceiling mount installation height 2.5m-6m)

	Mount height	Tangential (A)	Radial (B)
A: Tangential movement	2.5m	max 50m ² (Ø = 8m)	max 13m ² (Ø = 4m)
B: Radial movement	3m	max 64m ² (Ø = 9m)	max 13m ² (Ø = 4m)
	4m	max 38m ² (Ø = 7m)	max 13m ² (Ø = 4m)
	5m	max 38m ² (Ø = 7m)	max 13m ² (Ø = 4m)
	6m	max 38m ² (Ø = 7m)	max 13m ² (Ø = 4m)

Optional Accessory --- Ceiling/Surface Mount Box: HA03

Optional Accessory --- Blind Insert for Blocking Certain Detection Angles

Blind Option 1 --- Aisle Detection

Blind Option 2 --- 180° Detection

2. HIR28/R (Reinforced Low-bay)



HIR28/R: Low-bay convex lens detection pattern for **single person** @ $T_a = 20^\circ\text{C}$

(Recommended ceiling mount installation height **2.5m-6m**)

A: Tangential movement	B: Radial movement	Mount height	Tangential (A)	Radial (B)
		2.5m	max 79m ² (Ø = 10m)	max 20m ² (Ø = 5m)
		3m	max 79m ² (Ø = 10m)	max 20m ² (Ø = 5m)
		4m	max 64m ² (Ø = 9m)	max 20m ² (Ø = 5m)
		5m	max 50m ² (Ø = 8m)	max 20m ² (Ø = 5m)
		6m	max 50m ² (Ø = 8m)	max 20m ² (Ø = 5m)

Optional Accessory --- Ceiling/Surface Mount Box: HA03

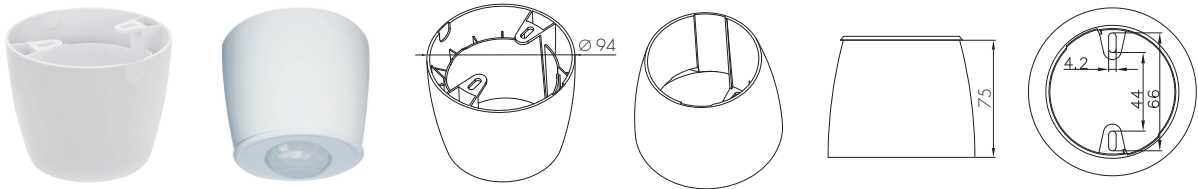

Optional Accessory --- Blind Insert for Blocking Certain Detection Angles

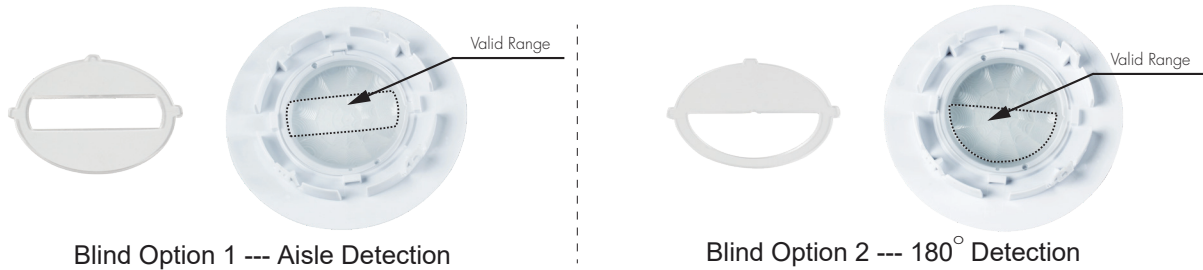

Blind Option 1 --- Aisle Detection

Blind Option 2 --- 180° Detection

3. HIR28/H (High-bay)



HIR28/H: High-bay lens detection pattern for forklift @ Ta = 20°C

(Recommended ceiling mount installation height **10m-15m**)

A: Tangential movement

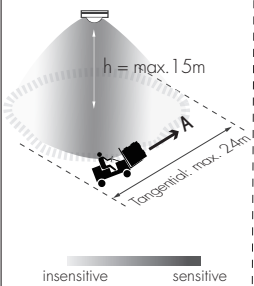

B: Radial movement

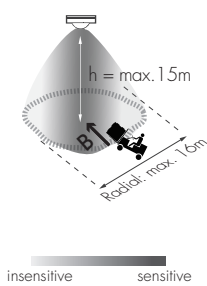

Mount height	Tangential (A)	Radial (B)
10m	max 380m ² (Ø = 22m)	max 201m ² (Ø = 16m)
11m	max 452m ² (Ø = 24m)	max 201m ² (Ø = 16m)
12m	max 452m ² (Ø = 24m)	max 201m ² (Ø = 16m)
13m	max 452m ² (Ø = 24m)	max 177m ² (Ø = 15m)
14m	max 452m ² (Ø = 24m)	max 133m ² (Ø = 13m)
15m	max 452m ² (Ø = 24m)	max 113m ² (Ø = 12m)



HIR28/H: High-bay lens detection pattern for single person @ Ta = 20°C

(Recommended ceiling mount installation height **2.5m-12m**)

A: Tangential movement

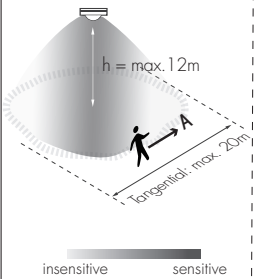

B: Radial movement

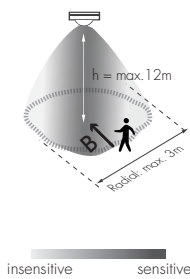

Mount height	Tangential (A)	Radial (B)
2.5m	max 50m ² (Ø = 8m)	max 7m ² (Ø = 3m)
6m	max 104m ² (Ø = 11.5m)	max 7m ² (Ø = 3m)
8m	max 154m ² (Ø = 14m)	max 7m ² (Ø = 3m)
10m	max 227m ² (Ø = 17m)	max 7m ² (Ø = 3m)
11m	max 269m ² (Ø = 18.5m)	max 7m ² (Ø = 3m)
12m	max 314m ² (Ø = 20m)	max 7m ² (Ø = 3m)

Optional Accessory --- Ceiling/Surface Mount Box: HA03

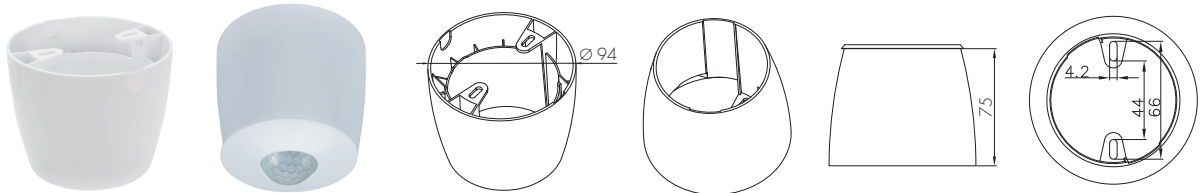

Optional Accessory --- Blind Insert for Blocking Certain Detection Angles

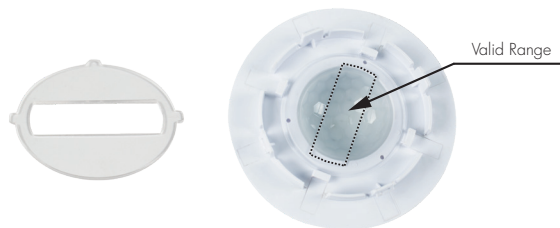

Blind Option 1 --- Aisle Detection

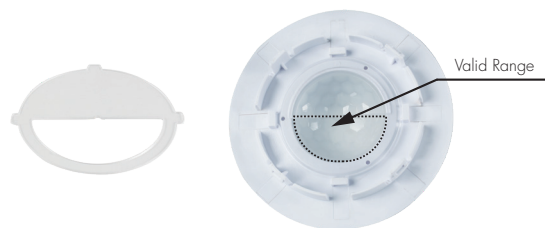

Blind Option 2 --- 180° Detection

4. HIR28/RH (Reinforced High-bay with 3-Pyro)



HIR28/RH: Reinforced high-bay lens detection pattern for **forklift** @ $T_a = 20^\circ\text{C}$
 (Recommended ceiling mount installation height **10m-15m**)

A: Tangential movement	B: Radial movement	Mount height	Tangential (A)	Radial (B)
		10m	max 346m ² (Ø = 21m)	max 177m ² (Ø = 15m)
		11m	max 660m ² (Ø = 29m)	max 177m ² (Ø = 15m)
		12m	max 907m ² (Ø = 34m)	max 154m ² (Ø = 14m)
		13m	max 962m ² (Ø = 35m)	max 154m ² (Ø = 14m)
		14m	max 1075m ² (Ø = 37m)	max 113m ² (Ø = 12m)
		15m	max 1256m ² (Ø = 40m)	max 113m ² (Ø = 12m)



HIR28/RH: Reinforced high-bay lens detection pattern for **single person** @ $T_a = 20^\circ\text{C}$
 (Recommended ceiling mount installation height **2.5m-12m**)

A: Tangential movement	B: Radial movement	Mount height	Tangential (A)	Radial (B)
		2.5m	max 38m ² (Ø = 7m)	max 7m ² (Ø = 3m)
		6m	max 154m ² (Ø = 14m)	max 7m ² (Ø = 3m)
		8m	max 314m ² (Ø = 20m)	max 7m ² (Ø = 3m)
		10m	max 531m ² (Ø = 26m)	max 13m ² (Ø = 4m)
		11m	max 615m ² (Ø = 28m)	max 13m ² (Ø = 4m)
		12m	max 707m ² (Ø = 30m)	max 13m ² (Ø = 4m)

Optional Accessory -- Ceiling/Surface Mount Box: HA03

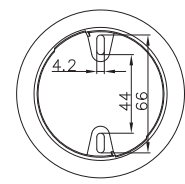
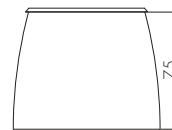
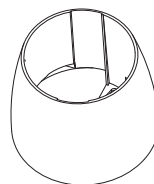
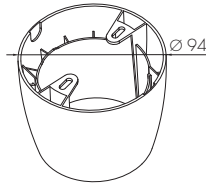

Functions and Features

1 On/ off Control

This sensor is a motion switch, which turns on the light upon detection of motion, and turns off after a pre-selected hold-time when there is no movement. A daylight sensor is also built in to prevent the light from switching on when there is sufficient natural light.

2 Intelligent Photocell (daylight detection prior to motion detection)

The built-in photocell will also automatically turn off the light when the ambient natural light exceeds the programmed lux level for more than 5min, regardless of whether motion is detected or not.



With sufficient natural light, the light does not switch on when presence is detected.

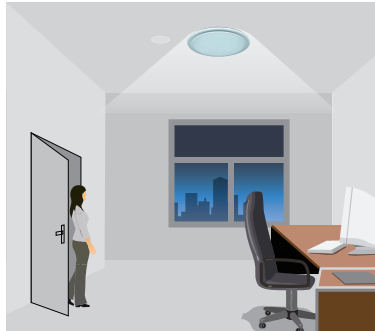

With insufficient natural light, the sensor switches on the light automatically when presence is detected.

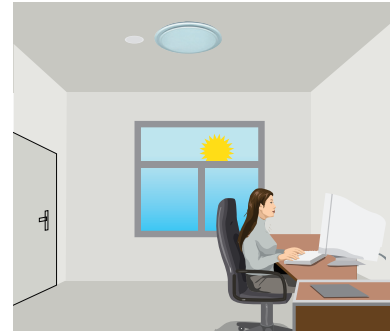

The sensor switches off the light when natural light is sufficient, even with presence.

3 Manual Override

With the help of push-switch, this sensor can be over-riden by the end-user to manually switch on/off the light, which makes the product more user-friendly and offers more options to fit some extra-ordinary demands:

* Short Push (< 1 s): on/off function;

On → Off: the light turns off immediately and cannot be triggered ON by motion until the expiration of pre-set hold-time. After this period, the sensor goes back to normal sensor mode.

Off → On: the light turns on and goes to sensor mode, no matter if ambient Lux level exceeds the daylight threshold or not.

Note: if end-user do not want this manual override function, just leave the "push" terminal unconnected to any wire.

4 Semi-auto Mode (Absence Detection)

It is easy to forget to switch off the light, in office, corridor, even at home. And in many other cases, people do not want to have a sensor to switch on the light automatically, for example, when people just quickly pass-by, there is no need to have the light on. The solution is to apply this "absence detector": motion sensor is employed, but only activated on the manual press of the push-switch, the light keeps being ON in the presence, and switches off in the long absence.

Note: end-user can choose either function 3 or function 4 for application. Default function is manual override.

5 Zero-cross Relay Operation

Designed in the software, sensor switches on/off the load right at the zero-cross point, to ensure that the in-rush current is minimised, enabling the maximum lifetime of the relay.

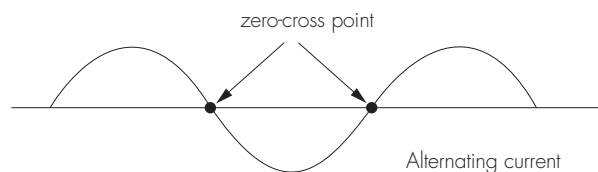

Settings (Remote Control HRC-1 1)



Permanent ON/OFF function

Press button "ON/OFF" to select permanent ON or permanent OFF mode.
* Press button "AUTO", "RESET" to quit this mode.



Reset Settings

Press button "RESET", all settings go back to default values as below:
Hold-time 5min, daylight threshold Disabled



Shift Button

Press button "Shift", the LED on the top left corner is on to indicate mode selection.
All values / settings in RED are valid for 20 seconds.



AUTO mode

Press button "AUTO" to initiate automatic mode. The sensor starts working and all settings remain as before the light is switched ON/OFF.



SEMI-AUTO mode

1. Press button "Shift", the red LED flashes for indication.
2. Press button "SEMI-AUTO/AUTO" to initiate semi-auto mode. The fixture is manually turned on by pressing the push-switch, and goes off automatically in this mode. (Absence detection mode)



Power output

These two buttons are disabled.



Brightness +/-

These two buttons are disabled.



Scene program - 1-key commissioning

1. Press button "Start" to program.
2. Select the buttons in "Detection range", "Daylight threshold", "Hold-time" to set all parameters.
3. Press button "Memory" to save all the settings programmed in the remote control.
4. Press button "Apply" to set the settings to each sensor unit(s).

For example, to set detection range 100%, daylight threshold Disable, hold-time 5min, the steps should be:

Press button "Start", button "100%", "Disable", "Shift", "5min", "Memory". By pointing to the sensor unit(s) and pressing "Apply", all settings are passed on the sensor(s).

Detection range

These buttons are disabled

Daylight threshold

Press buttons in zone "Daylight threshold" to set daylight sensor at 2Lux / 10Lux / 50Lux / 100Lux / 300Lux / 500Lux / Disable.

Note: To set daylight sensor at 100Lux / 300Lux / 500Lux, press "Shift" button first.

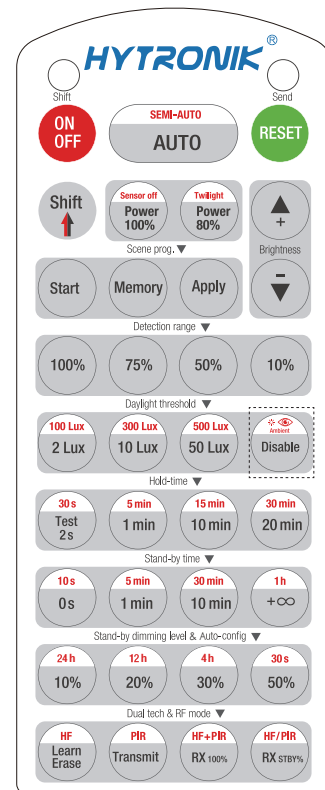

HRC-11

Ambient daylight threshold

1. Press button "Shift", the red LED starts to flash.
2. Press button "Ambient", the surrounding lux level is sampled and set as the new daylight threshold.

Hold-time

Press buttons in zone "hold-time" to set the hold-time at 2s / 30s / 1min / 5min / 10min / 15min / 20min / 30min.

Note: 1. To set hold-time at 30s / 5min / 15min / 30min, press "Shift" button first.

2. 2s is for testing purpose only, stand-by period and daylight sensor settings are disabled in this mode.

*To exit from Test mode, press button "RESET" or any button in "Hold-time".

All buttons in zone "Stand-by time", "Stand-by dimming level & Auto-config", "Dual-tech & RF mode" are disabled.

Additional Information / Documents

1. Regarding precautions for PIR sensor installation and operation, please kindly refer to [www.hytronik.com/download ->knowledge ->PIR Sensors - Precautions for Product Installation and Operation](http://www.hytronik.com/download->knowledge->PIR%20Sensors%20-%20Precautions%20for%20Product%20Installation%20and%20Operation)
2. Regarding Hytronik standard guarantee policy, please refer to [www.hytronik.com/download ->knowledge ->Hytronik Standard Guarantee Policy](http://www.hytronik.com/download->knowledge->Hytronik%20Standard%20Guarantee%20Policy)